

OPALED ASENNUSOHJE

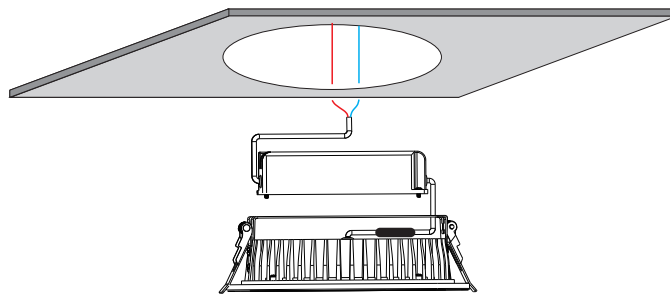

1. Kytke driveri valaisimeen. Tämän jälkeen kytke driveri verkkovirtaan.

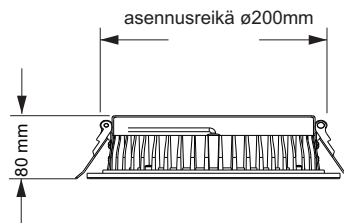
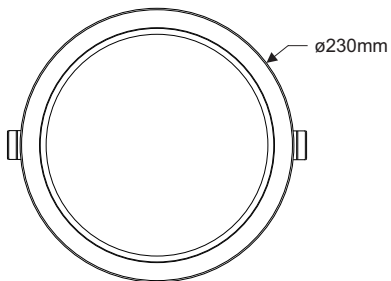
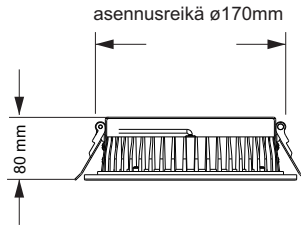
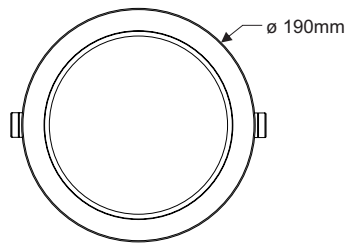
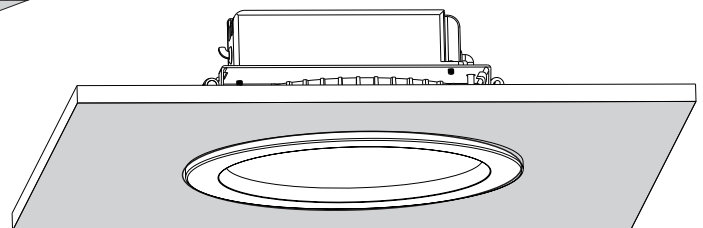
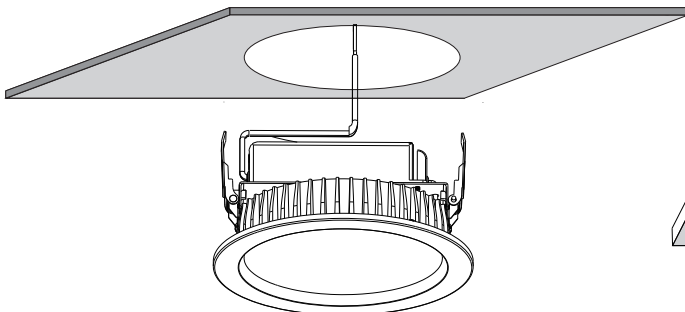

2. Paina valaisimen jouset ylös ja asenna valaisin asennusreikään.